

TENTATIVE TOSHIBA CCD ANALOG PROCESSOR INTEGRATED CIRCUIT SILICON MONOLITHIC

# TL8857F

## NTSC SKEW CORRECTION IC FOR VCR

The TL8857F is the skew correction IC for the search playback signal of NTSC SP mode by 4 head PAL cylinder. This skew is made by the difference of 1H length on tape between NTSC (525 lines) and PAL (625 lines)

PAL : 625 lines = 2H

NTSC : 525 lines =  $(2 / 625) \times 525 = 1.68H$

Difference (Skew) =  $2H - 1.68H = 0.32H$

TL8857F corrects the skew by changing the delay time of CCD delay lines.

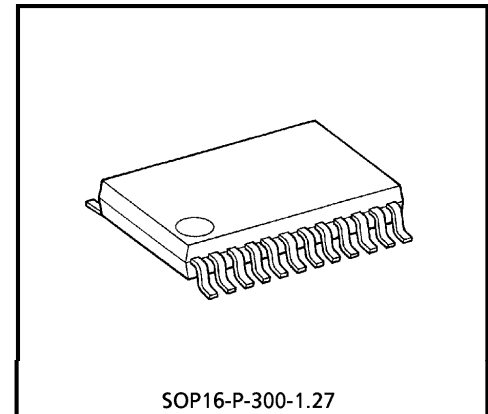

Weight : 0.2g (Typ.)

### FEATURES

- CCD DELAY LINES  
NTSC 0.32H/0H DELAY LINES (Apply to both 3.58NTSC and 4.43NTSC)
- SYNC TIP CLAMP CIRCUIT
- CCD DRIVE CIRCUIT, SAMPLE AND HOLD CIRCUIT
- 2 input SW (For the through mode)
- 2 input SW is controlled by Pin 13  
Low = Through (EE) mode  
High = Skew (correction) mode
- When Pin 13 is Low the CCD clock driver is off and the CCD output (Pin 8) is fixed to DC

980508EBA1

- TOSHIBA is continually working to improve the quality and the reliability of its products. Nevertheless, semiconductor devices in general can malfunction or fail due to their inherent electrical sensitivity and vulnerability to physical stress. It is the responsibility of the buyer, when utilizing TOSHIBA products, to observe standards of safety, and to avoid situations in which a malfunction or failure of a TOSHIBA product could cause loss of human life, bodily injury or damage to property. In developing your designs, please ensure that TOSHIBA products are used within specified operating ranges as set forth in the most recent products specifications. Also, please keep in mind the precautions and conditions set forth in the TOSHIBA Semiconductor Reliability Handbook.
- The products described in this document are subject to foreign exchange and foreign trade laws.
- The information contained herein is presented only as a guide for the applications of our products. No responsibility is assumed by TOSHIBA CORPORATION for any infringements of intellectual property or other rights of the third parties which may result from its use. No license is granted by implication or otherwise under any intellectual property or other rights of TOSHIBA CORPORATION or others.
- The information contained herein is subject to change without notice.

- The CCD delay time is 2 mode. 0H and 0.32H, controlled by Pin 14.  
Low = 0H  
High = 0.32H
- PLL frequency multiplier is built in. 3.58NTSC and 4.43NTSC are selected by Pin 15.  
Low = 4.43NTSC  
High = 3.58NTSC
- Input signal is sampling by 4 times (3.58NTSC) or 3 times (4.43NTSC) of subcarrier frequency, generated by internal PLL multiplier.
- 5V single power supply.
- As all supporting circuit for CCD such as CCD driver, bias generators and output amplifiers are built in, minimum external parts are needed.
- The output signal at pin 8 is inverted.

BLOCK DIAGRAM

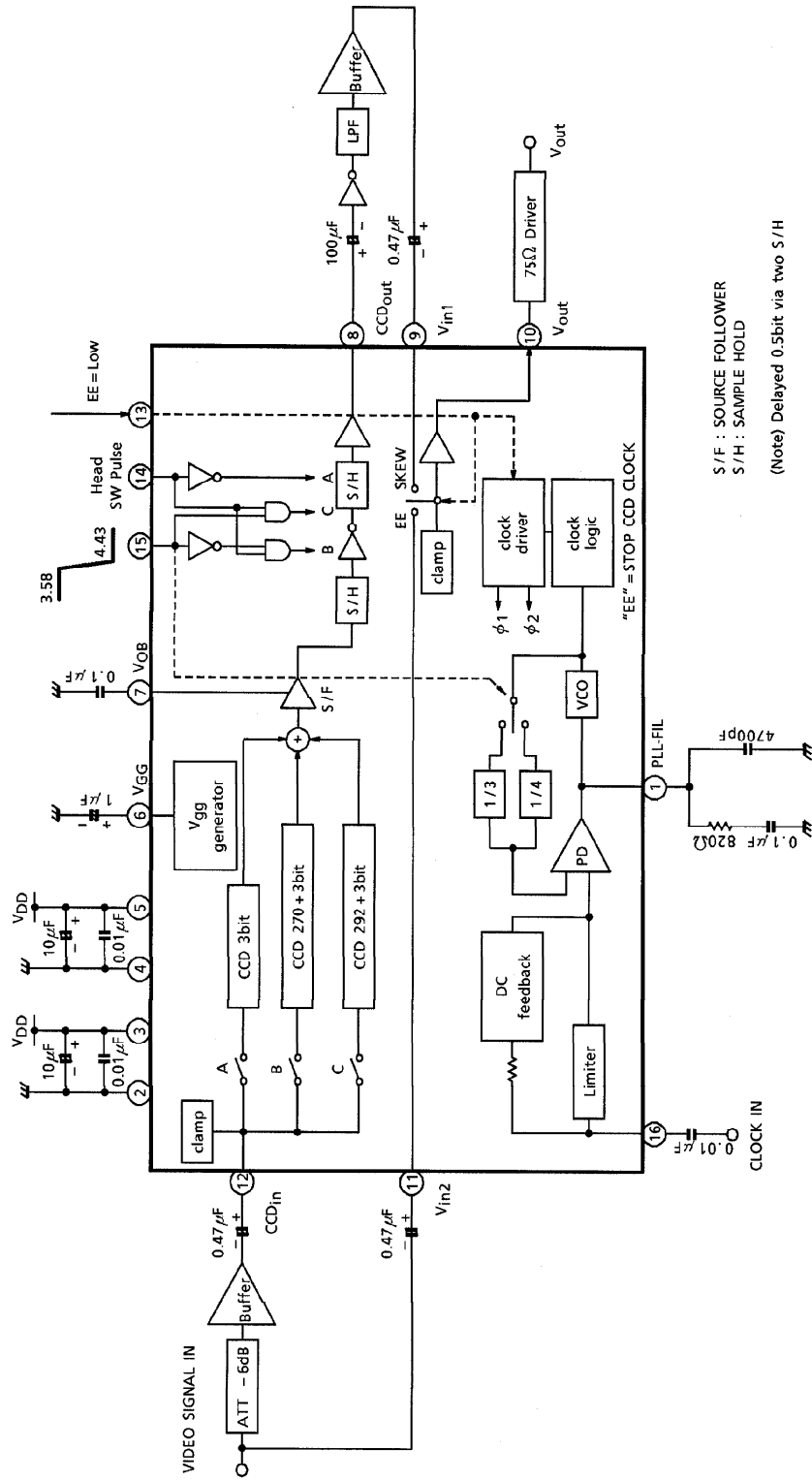

PIN LIST

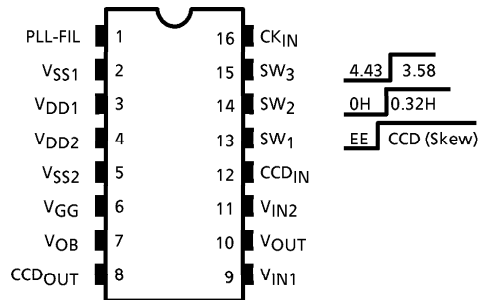

MAXIMUM RATINGS (Ta = 25°C)

CHARACTERISTIC	SYMBOL	RATING	UNIT
Supply Voltage	V <sub>DD</sub>	6	V
Input Voltage	V <sub>IN</sub>	-0.3~V <sub>DD</sub> +0.3	V
Power Dissipation	P <sub>D</sub> (Note 1)	300	mW
Operating Temperature	T <sub>opr</sub> (Note 2)	0~60	°C
Storage Temperature	T <sub>stg</sub>	-55~150	°C

(Note 1) Ta = 60°C

(Note 2) Frost isn't to stick to the condition.

ELECTRICAL CHARACTERISTICS

DC CHARACTERISTIC (Ta = 25°C, V<sub>DD</sub> = 5.0V)

CHARACTERISTIC	SYMBOL	TEST CIRCUIT	TEST CONDITION	MIN.	TYP.	MAX.	UNIT
Operating Supply Voltage	V <sub>DD</sub>	—	SKEW, 3.58NTSC mode V <sub>in</sub> = No signal CLOCK = 3.579545MHz 300mV <sub>p-p</sub> Pin 13, 14, 15 = "Hi" = 5V DC Input	4.75	5.0	5.25	V
Supply Current	I <sub>DD</sub>	—		8.0	13.0	18.0	mA
Output DC Level	CCD <sub>out</sub>	—		3.0	3.6	4.2	V
	V <sub>OUT</sub>	—		1.5	2.0	2.5	
Pin DC Level	CCD <sub>in</sub>	—		2.5	2.9	3.3	
	V <sub>IN1</sub>	—		0.4	0.8	1.2	
	V <sub>IN2</sub>	—		0.4	0.8	1.2	
	V <sub>OB</sub>	—		0.9	1.5	2.1	
	PLL-FIL	—		0.5	1.5	2.5	
	CLOCK IN	—		1.3	2.3	3.3	
	V <sub>GG</sub>	—	8.0	10.0	12.0		
Switch Input Select Level Pin Voltage	SW <sub>1</sub> IL	—	—	—	1.5		
	SW <sub>1</sub> IH	—	3.5	—	—		
	SW <sub>2</sub> IL	—	—	—	1.5		
	SW <sub>2</sub> IH	—	3.5	—	—		
	SW <sub>3</sub> IL	—	—	—	1.5		
	SW <sub>3</sub> IH	—	3.5	—	—		

**ELECTRICAL CHARACTERISTICS (3.58NTSC mode, CCD part)**

**AC CHARACTERISTIC**

(Ta = 25°C, V<sub>DD</sub> = 5.0V, clock = 3.579545MHz, 0.3V<sub>p-p</sub>, S<sub>2</sub> = 2, S<sub>3</sub> = 2, S<sub>4</sub> = 1, S<sub>6</sub> = 1, S<sub>8</sub> = 1)

CHARACTERISTIC	SYM-BOL	TEST CIR-CUIT	TEST CONDITION	MIN.	TYP.	MAX.	UNIT		
Input Level	V <sub>IN</sub>	1	—	—	1.0	1.2	V <sub>p-p</sub>		
Voltage Gain	G <sub>V1</sub>	1	S <sub>1</sub> = 1, S <sub>7</sub> = 2, S <sub>9</sub> = 1, S <sub>10</sub> = 1, S <sub>11</sub> = 2 V <sub>IN</sub> = 15.625kHz, 0.6V <sub>p-p</sub> (Fig.2-b)	S <sub>5</sub> = 2 (0H)	0	2.0	4.0	dB	
	G <sub>V2</sub>			S <sub>5</sub> = 1 (0.32H)	0	2.0	4.0		
Frequency Characteristic	G <sub>f1</sub>	1	S <sub>1</sub> = 1, S <sub>7</sub> = 2, S <sub>9</sub> = 1, S <sub>10</sub> = 1, S <sub>11</sub> = 2 V <sub>IN</sub> = 15.625kHz / 4.5MHz, 0.6V <sub>p-p</sub> (Fig.2-b)	S <sub>5</sub> = 2 (0H)	-3	-2	—	dB	
	G <sub>f2</sub>			S <sub>5</sub> = 1 (0.32H)	-3	-2	—		
Differential Gain	DG1	1	S <sub>1</sub> = 1, S <sub>7</sub> = 1, S <sub>9</sub> = 1, S <sub>10</sub> = 1, S <sub>11</sub> = 3 V <sub>IN</sub> = 5 step signal, 1.0V <sub>p-p</sub> Y = 140IRE = 1.0V <sub>p-p</sub> , C = 40IRE (Fig.3)	S <sub>5</sub> = 2 (0H)	—	5	7	%	
	DG2			S <sub>5</sub> = 1 (0.32H)	—	5	7		
Differential Phase	DP1	1	DG = (C <sub>Omax</sub> - C <sub>Omin</sub> ) / C <sub>Omin</sub> (Fig.5)	S <sub>5</sub> = 2 (0H)	—	5	7	deg	
	DP2			S <sub>5</sub> = 1 (0.32H)	—	5	7		
Linearity	L <sub>s1</sub>	1	S <sub>1</sub> = 1, S <sub>7</sub> = 1, S <sub>9</sub> = 1, S <sub>10</sub> = 2, S <sub>11</sub> = 1 V <sub>IN</sub> = 5 step signal, 1.0V <sub>p-p</sub> (Fig.2-a, Fig.4)	S / Y <sub>2</sub>	S <sub>5</sub> = 2 (0H)	37	40	43	%
					S <sub>5</sub> = 1 (0.32H)	37	40	43	
	L <sub>y1</sub>	1		Y <sub>1</sub> / Y <sub>2</sub>	S <sub>5</sub> = 2 (0H)	56	60	64	
					S <sub>5</sub> = 1 (0.32H)	56	60	64	
Output Impedance	Z <sub>O1</sub>	1	S <sub>1</sub> = 1, S <sub>7</sub> = 2, S <sub>10</sub> = 1, S <sub>11</sub> = 1 V <sub>IN</sub> = 15.625kHz, 0.6V <sub>p-p</sub> (Fig.2-b) Z <sub>O</sub> = (V <sub>1</sub> - V <sub>2</sub> ) / V <sub>2</sub> × 1000 V <sub>1</sub> : S <sub>9</sub> = 1, V <sub>2</sub> : S <sub>9</sub> = 2	S <sub>5</sub> = 2 (0H)	100	250	400	Ω	
				S <sub>5</sub> = 1 (0.32H)	100	250	400		
Clock Input Level	V <sub>ck</sub>	1	—	0.2	0.3	0.7	V <sub>p-p</sub>		
Clock Leak (4fsc)	L <sub>ck</sub> 14.3	1	S <sub>1</sub> = 2, S <sub>7</sub> = 1, S <sub>9</sub> = 1, S <sub>10</sub> = 1, S <sub>11</sub> = 2 V <sub>IN</sub> = No signal	S <sub>5</sub> = 2 (0H)	—	20	40	mV <sub>rms</sub>	
				S <sub>5</sub> = 1 (0.32H)	—	20	40		
Clock Leak (fsc)	L <sub>sc</sub> 3.58	1	S <sub>1</sub> = 2, S <sub>7</sub> = 1, S <sub>9</sub> = 1, S <sub>10</sub> = 1, S <sub>11</sub> = 2 V <sub>IN</sub> = No signal	S <sub>5</sub> = 2 (0H)	—	1	2	mV <sub>rms</sub>	
				S <sub>5</sub> = 1 (0.32H)	—	1	2		

**ELECTRICAL CHARACTERISTIC (4.43NTSC mode, CCD part)**

**AC CHARACTERISTIC**

(Ta = 25°C, V<sub>DD</sub> = 5.0V, clock = 4.43361875MHz, 0.3V<sub>p-p</sub>, S<sub>2</sub> = 2, S<sub>3</sub> = 2, S<sub>4</sub> = 2, S<sub>6</sub> = 1, S<sub>8</sub> = 1)

CHARACTERISTIC	SYMBOL	TEST CIRCUIT	TEST CONDITION	MIN.	TYP.	MAX.	UNIT		
Input Level	V <sub>IN</sub>	1	—	—	1.0	1.2	V <sub>p-p</sub>		
Voltage Gain	G <sub>v3</sub>	1	S <sub>1</sub> = 2, S <sub>7</sub> = 2, S <sub>9</sub> = 1, S <sub>10</sub> = 1, S <sub>11</sub> = 2 V <sub>IN</sub> = 15.625kHz, 0.6V <sub>p-p</sub> (Fig.2-b)	S <sub>5</sub> = 2 (0H)	0	2.0	4.0	dB	
	G <sub>v4</sub>			S <sub>5</sub> = 1 (0.32H)	0	2.0	4.0		
Frequency Characteristic	G <sub>f3</sub>	1	S <sub>1</sub> = 2, S <sub>7</sub> = 2, S <sub>9</sub> = 1, S <sub>10</sub> = 1, S <sub>11</sub> = 2 V <sub>IN</sub> = 15.625kHz / 4.5MHz, 0.6V <sub>p-p</sub> (Fig.2-b)	S <sub>5</sub> = 2 (0H)	-3	-2	—	dB	
	G <sub>f4</sub>			S <sub>5</sub> = 1 (0.32H)	-3	-2	—		
Differential Gain	DG3	1	S <sub>1</sub> = 2, S <sub>7</sub> = 1, S <sub>9</sub> = 1, S <sub>10</sub> = 1, S <sub>11</sub> = 3 V <sub>IN</sub> = 5 step signal, 1.0V <sub>p-p</sub> Y = 140IRE = 1.0V <sub>p-p</sub> , C = 40IRE (Fig.3)	S <sub>5</sub> = 2 (0H)	—	5	7	%	
	DG4			S <sub>5</sub> = 1 (0.32H)	—	5	7		
Differential Phase	DP3	1	DG = (CO <sub>max</sub> - CO <sub>min</sub> ) / CO <sub>min</sub> (Fig.5)	S <sub>5</sub> = 2 (0H)	—	5	7	deg	
	DP4			S <sub>5</sub> = 1 (0.32H)	—	5	7		
Linearity	L <sub>s2</sub>	1	S <sub>1</sub> = 2, S <sub>7</sub> = 1, S <sub>9</sub> = 1, S <sub>10</sub> = 2, S <sub>11</sub> = 1 V <sub>IN</sub> = 5 step signal, 1.0V <sub>p-p</sub> (Fig.2-a, Fig.4)	S / Y <sub>2</sub>	S <sub>5</sub> = 2 (0H)	37	40	43	%
					S <sub>5</sub> = 1 (0.32H)	37	40	43	
	L <sub>y2</sub>	1		Y <sub>1</sub> / Y <sub>2</sub>	S <sub>5</sub> = 2 (0H)	56	60	64	
					S <sub>5</sub> = 1 (0.32H)	56	60	64	
Output Impedance	Z <sub>O2</sub>	1	S <sub>1</sub> = 2, S <sub>7</sub> = 2, S <sub>10</sub> = 1, S <sub>11</sub> = 1 V <sub>IN</sub> = 15.625kHz, 0.6V <sub>p-p</sub> (Fig.2-b) Z <sub>O</sub> = (V <sub>1</sub> - V <sub>2</sub> ) / V <sub>2</sub> × 1000 V <sub>1</sub> : S <sub>9</sub> = 1, V <sub>2</sub> : S <sub>9</sub> = 2	S <sub>5</sub> = 2 (0H)	100	250	400	Ω	
				S <sub>5</sub> = 1 (0.32H)	100	250	400		
Clock Input Level	V <sub>ck</sub>	1	—	0.2	0.3	0.7	V <sub>p-p</sub>		
Clock Leak (3fsc)	L <sub>ck</sub> 13.3	1	S <sub>1</sub> = 2, S <sub>7</sub> = 2, S <sub>9</sub> = 1, S <sub>10</sub> = 1, S <sub>11</sub> = 2 V <sub>IN</sub> = No signal	S <sub>5</sub> = 2 (0H)	—	20	40	mV <sub>rms</sub>	
				S <sub>5</sub> = 1 (0.32H)	—	20	40		
Clock Leak (fsc)	L <sub>sc</sub> 4.43	1	S <sub>1</sub> = 2, S <sub>7</sub> = 2, S <sub>9</sub> = 1, S <sub>10</sub> = 1, S <sub>11</sub> = 2 V <sub>IN</sub> = No signal	S <sub>5</sub> = 2 (0H)	—	1	2	mV <sub>rms</sub>	
				S <sub>5</sub> = 1 (0.32H)	—	1	2		

**ELECTRICAL CHARACTERISTIC** Commonness (SW part)

AC CHARACTERISTIC (Ta = 25°C, VDD = 5.0V, clock = 3.579545MHz or 4.43361875MHz, 0.3Vp-p, S1 = 2, S4 = 1 or 2, S5 = 1 or 2, S8 = 2, S10 = 1)

CHARACTERISTIC	SYM-BOL	TEST CIR-CUIT	TEST CONDITION	MIN.	TYP.	MAX.	UNIT		
Input Level	VIN	1	—	—	2.0	2.4	Vp-p		
Through Mode Voltage Gain	Gv5	1	S7 = 2, Sg = 1, S11 = 2 VIN = 15.625kHz, 1.2Vp-p (Fig.6-b)	S6 = 2, S2 = 1, S3 = 2 (Pin 11→Pin 10)	-1.5	-0.5	0.5	dB	
	Gv6			S6 = 1, S2 = 2, S3 = 1 (Pin 9→Pin 10)	-1.5	-0.5	0.5		
Through Mode Frequency Characteristic	fth1	1	S7 = 2, Sg = 1, S11 = 2 VIN = 15.625kHz / 4.5MHz, 1.2Vp-p (Fig.6-b)	S6 = 2, S2 = 1, S3 = 2 (Pin 11→Pin 10)	-1.0	0	1.0	dB	
	fth2			S6 = 1, S2 = 2, S3 = 1 (Pin 9→Pin 10)	-1.0	0	1.0		
Differential Gain	DG5	1	S7 = 1, Sg = 1, S11 = 3 VIN = 5 step signal, 2.0Vp-p Y = 140IRE = 1.0Vp-p, C = 40IRE (Fig.7) DG = (C0max - C0min) / C0min (Fig.5)	S6 = 2, S2 = 1, S3 = 2 (Pin 11→Pin 10)	—	3	5	%	
	DG6			S6 = 1, S2 = 2, S3 = 1 (Pin 9→Pin 10)	—	3	5		
Differential Phase	DP5	1	S7 = 1, Sg = 1, S11 = 3 VIN = 5 step signal, 2.0Vp-p Y = 140IRE = 1.0Vp-p, C = 40IRE (Fig.7) DG = (C0max - C0min) / C0min (Fig.5)	S6 = 2, S2 = 1, S3 = 2 (Pin 11→Pin 10)	—	3	5	deg	
	DP6			S6 = 1, S2 = 2, S3 = 1 (Pin 9→Pin 10)	—	3	5		
Linearity	Ls3	1	S7 = 1, Sg = 1, S11 = 1 VIN = 5 step signal, 2.0Vp-p (Fig.6-a, Fig.4)	S / Y2	S6 = 2, S2 = 1, S3 = 2 (Pin 11→Pin 10)	37	40	43	%
					S6 = 1, S2 = 2, S3 = 1 (Pin 9→Pin 10)	37	40	43	
	Ly3	1		Y1 / Y2	S6 = 2, S2 = 1, S3 = 2 (Pin 11→Pin 10)	56	60	64	%
					S6 = 1, S2 = 2, S3 = 1 (Pin 9→Pin 10)	56	60	64	
Output Impedance	Z0	1	S7 = 2, S11 = 1 VIN = 15.625kHz, 1.2Vp-p (Fig.6-b) Z0 = (V1 - V2) / V2 × 1000 V1 : Sg = 1, V2 : Sg = 2	S6 = 2, S2 = 1, S3 = 2 (Pin 11→Pin 10)	100	250	400	Ω	
				S6 = 1, S2 = 2, S3 = 1 (Pin 9→Pin 10)	100	250	400		

TEST CIRCUIT

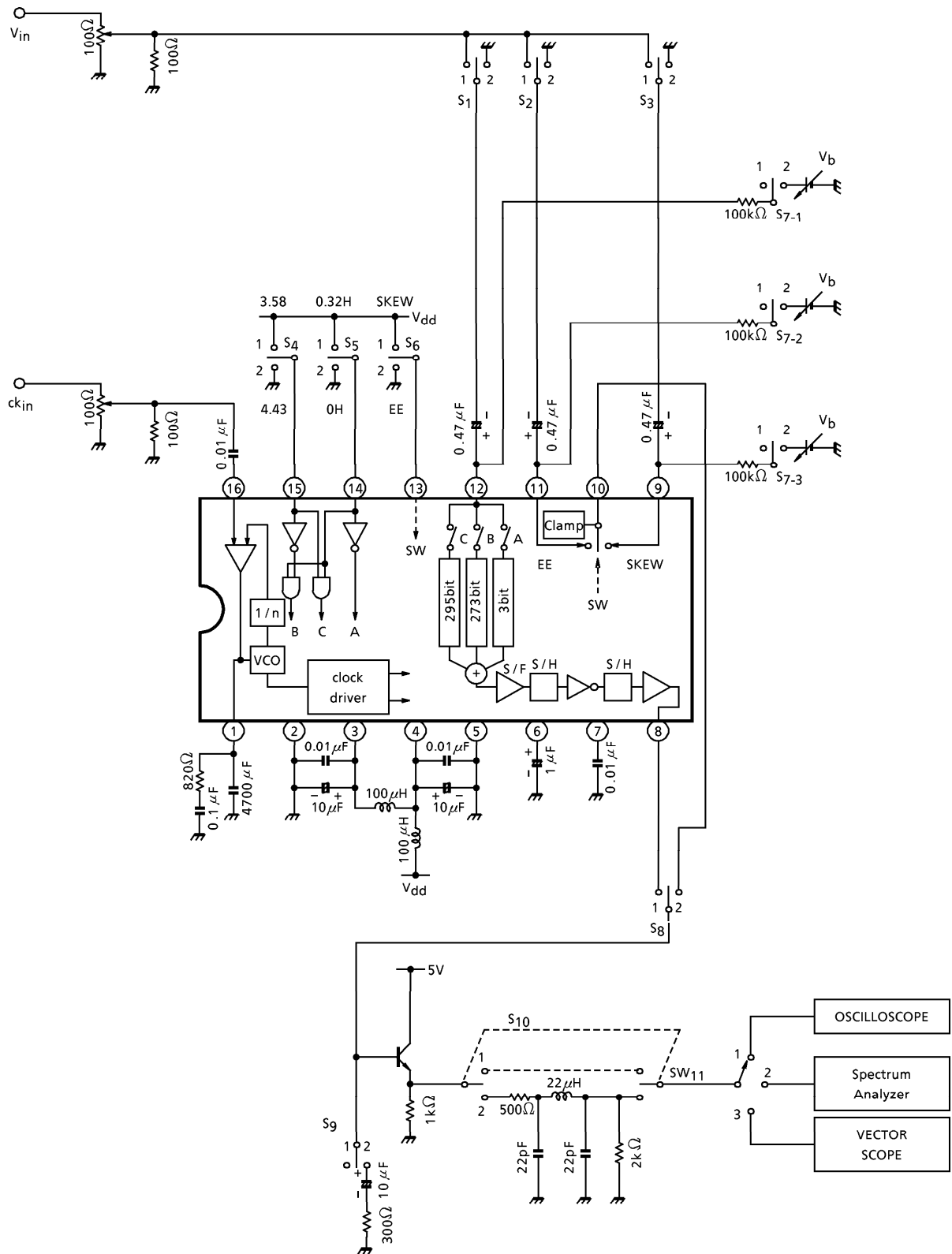
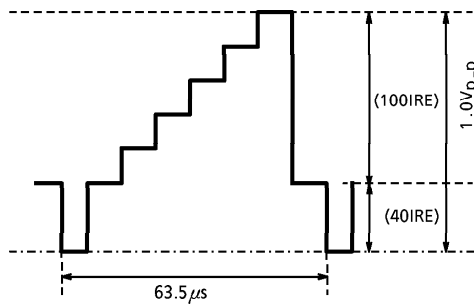

Fig.1



**INPUT SIGNAL DC LEVEL**

(a) 5 step staircase signal  
(Clamp Operation)



(b) Sine wave input  
(0.6Vp-p input)

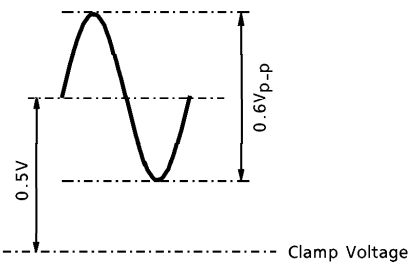

**Fig.2**

**5 STEP STAIRCASE SIGNAL**

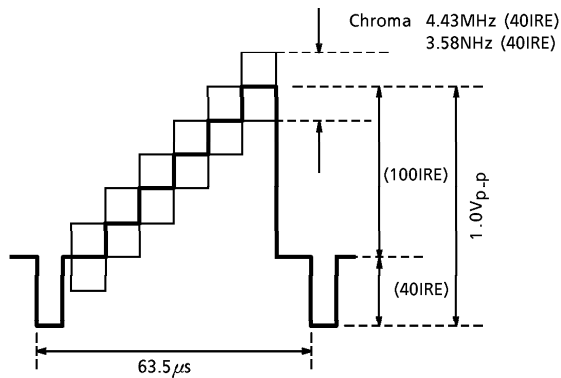

**Fig.3**

**LINEARITY TEST SIGNAL OUTPUT**

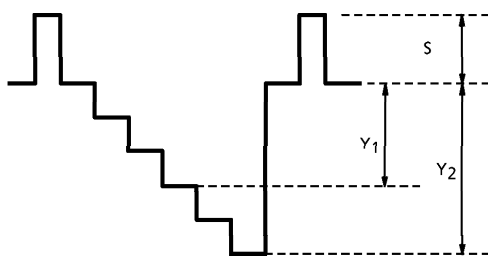

**Fig.4**

**CHROMA DIFFERENTIAL GAIN**

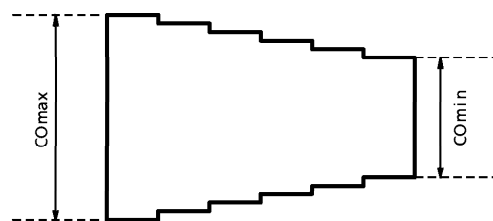

**Fig.5**

**INPUT SIGNAL DC LEVEL**

(a) 5 step staircase signal  
(Clamp operation)

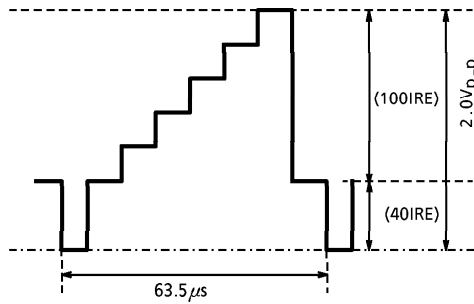

(b) Sine wave input  
(1.2Vp-p input)

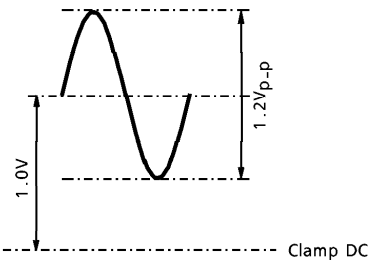

**Fig.6**

**5 STEP STAIRCASE SIGNAL**

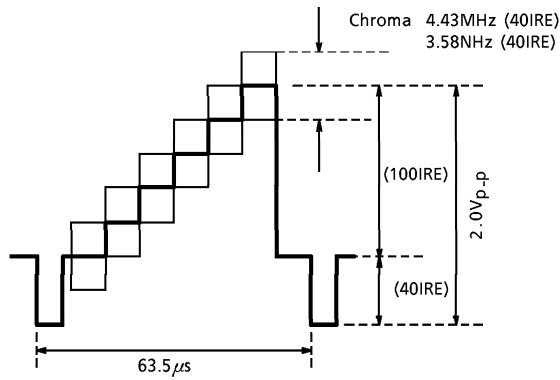

**Fig.7**



**ATTENTION IN TREATMENT**

This device is electrostatic sensitive device, so care must be taken in handling and storage to prevent deterioration or damage by means of shorting electrically all pins with use of aluminum foil or conductive mat.

Even in assembled on board, it is necessary to protect against surge or inductive noise from input, output and power supply line.

**OUTLINE DRAWING**  
SOP16-P-300-1.27

Unit : mm

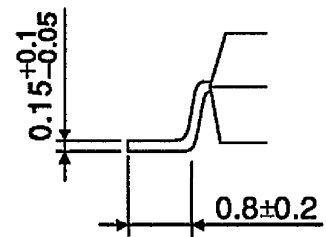
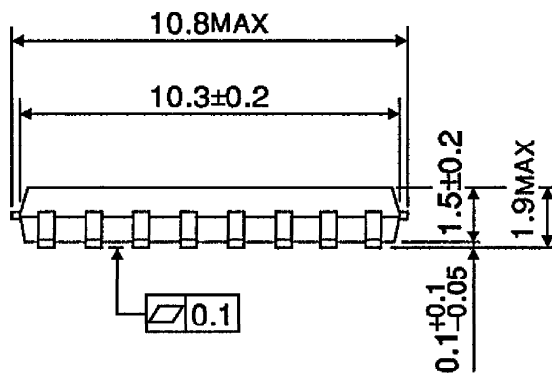
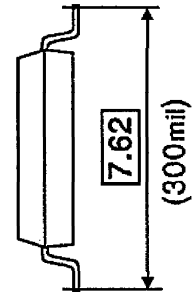
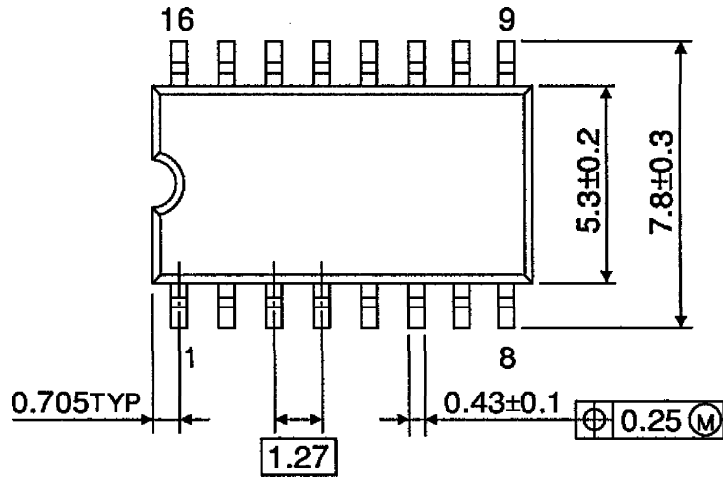

Weight : 0.2g (Typ.)